

# ECOLINE

## Preparazione 700

Il programma di preparazione statica Ecoline offre una gamma completa di prodotti (dai tavoli agli armadi, dai lavelli ai pensili, dagli scaffali ai lavamani) e coniuga con successo la qualità dei prodotti con la loro economicità.

Caratteristiche generali: piano di lavoro da 40 mm • Piano inox AISI 304 spessore 8/10 mm; struttura spessore 10/10 mm  
• Profili diritti • Gambe a sezione quadra 40 x 40 mm.



# ECOLINE

## CONFIGURATORE PREPARAZIONE

### Piani di Lavoro

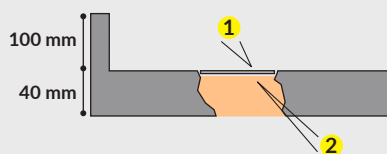

1. Piano inox AISI 304 spessore 8/10 mm
2. Sottopiano in truciolare nobilitato idrofugo e fonoassorbente spessore 18 mm

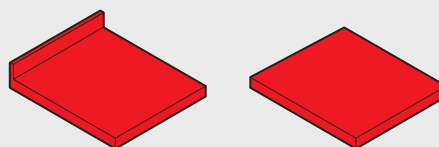

...A

...B

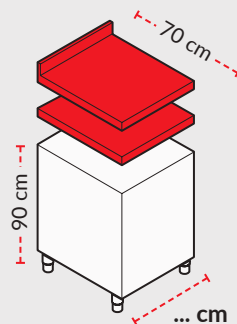

### PREPARAZIONE 700 Armadi con porte a battente e cassetti • Armadi con porte a coulisse e cassetti

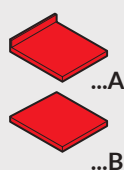
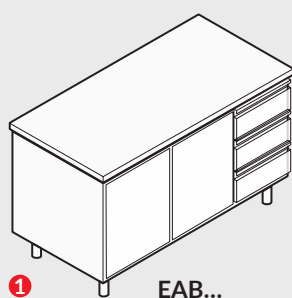

1

EAB...

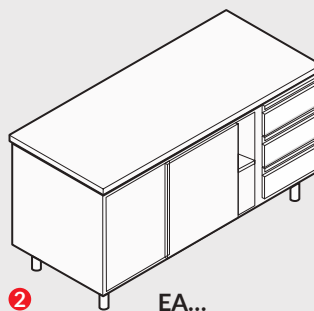

2

EA...

140

160

180

200 cm

1

  
EAB14AC3 • EAB14BC3

2

  
EA16AC3D/S • EA16BC3D/S

  
EA18AC3D/S • EA18BC3D/S

  
EA20AC3D/S • EA20BC3D/S

\* ...D: cassettera a destra • ...S: cassettera a sinistra

### PREPARAZIONE 700 Tavoli con vasca

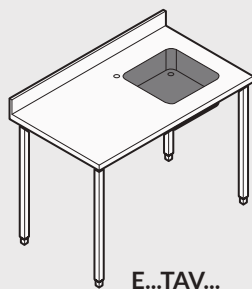

E...TAV...

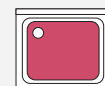

cm 50x40x25 h

\* ...VD: vasca destra  
...VS: vasca sinistra

120

160

180 cm

  
E12TAVD • E12TAVS

  
E16TAVD • E16TAVS

  
E18TAVD • E18TAVS

# ECOLINE

## CONFIGURATORE PREPARAZIONE

### PREPARAZIONE 700 Lavelli

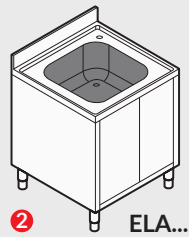
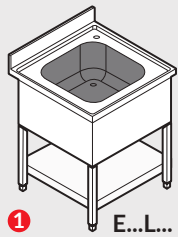

cm 40x50x30 h



cm 50x50x30 h

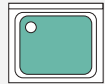

cm 60x50x30 h



cm 70x50x35 h

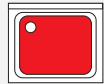

cm 80x50x35 h



cm 106x50x35 h

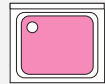

cm 116x50x35 h

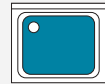

cm 136x50x35 h

\* In dotazione: piletta di scarico da 1,5", tubo troppopieno, sifone e ripiano di fondo • ...D: sgocciolatoio a destra • ...S: sgocciolatoio a sinistra

	70	80	100	120	140	160	180	200 cm
1	E07L15	E08L165	E10L15D/S E10L245 E10L18	E12L15D/S E12L25 E12L111	E14L15D/S E14L265 E14L112	E16L25D/S E16L114 E16L27	E18L265D/S E18L28	E20L265D/S E20L28
2	ELA0715	ELA08165	ELA1015D/S	ELA1215D/S ELA1225	ELA1415D/S	ELA1625D/S	E18L265D/S	

### PREPARAZIONE 700 Lavelli predistosti per lavastoviglie

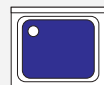
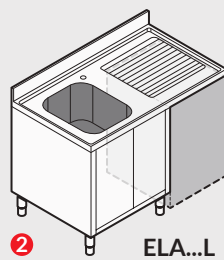
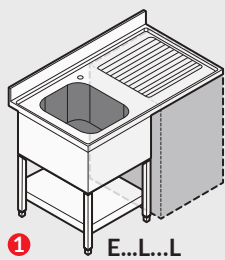

cm 40x50x30 h

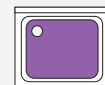

cm 50x50x30 h

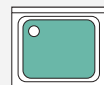

cm 60x50x30 h







\* D: lavastoviglie a destra • S: lavastoviglie a sinistra

	120	140	160	180	200 cm
1	E12L15DL • E12L15SL	E14L15DL • E14L15SL	E16L24DL • E16L24SL	E18L25DL • E18L25SL	E20L26DL • E20L26SL
2	ELA121DL • ELA121SL	ELA141DL • ELA141SL	ELA162DL • ELA162SL	ELA182DL • ELA182SL	



# PREPARAZIONE ECOLINE 700

## TAVOLI DA LAVORO

Montaggio con viti. Consegnato smontato. ...B: piano di lavoro bifronte.  
...A: piano di lavoro con alzatina.

MOD.	DESCRIZIONE				
	<b>E07TB</b>	TAVOLO CON PIANO BIFRONT 70 CM	70X70X90		
	<b>E08TB</b>	TAVOLO CON PIANO BIFRONT 80 CM	80X70X90		
	<b>E10TB</b>	TAVOLO CON PIANO BIFRONT 100 CM	100X70X90		
	<b>E12TB</b>	TAVOLO CON PIANO BIFRONT 120 CM	120X70X90		
	<b>E14TB</b>	TAVOLO CON PIANO BIFRONT 140 CM	140X70X90		
	<b>E16TB</b>	TAVOLO CON PIANO BIFRONT 160 CM	160X70X90		
	<b>E18TB</b>	TAVOLO CON PIANO BIFRONT 180 CM	180X70X90		
	<b>E20TB</b>	TAVOLO CON PIANO BIFRONT 200 CM	200X70X90		
	<b>E07TA</b>	TAVOLO CON PIANO E ALZATINA 70 CM	70X70X90		
	<b>E08TA</b>	TAVOLO CON PIANO E ALZATINA 80 CM	80X70X90		
	<b>E10TA</b>	TAVOLO CON PIANO E ALZATINA 100 CM	100X70X90		
	<b>E12TA</b>	TAVOLO CON PIANO E ALZATINA 120 CM	120X70X90		
	<b>E14TA</b>	TAVOLO CON PIANO E ALZATINA 140 CM	140X70X90		
	<b>E16TA</b>	TAVOLO CON PIANO E ALZATINA 160 CM	160X70X90		
	<b>E18TA</b>	TAVOLO CON PIANO E ALZATINA 180 CM	180X70X90		
	<b>E20TA</b>	TAVOLO CON PIANO E ALZATINA 200 CM	200X70X90		

### ACCESSORI

MOD.	DESCRIZIONE				
	<b>E04C111</b>	CASSETTO 40 CM GN 1/1	40X65X15		

## ACCESSORI

	MOD.	DESCRIZIONE				
	<b>E04C311</b>	3 CASSETTI 40 CM	40X65X56			
	<b>E06C111</b>	CASSETTO 60 CM GN 2/1	60X65X15			
	<b>E06C311</b>	3 CASSETTI 60 CM	60X65X56			
	<b>KRPECOTV</b>	KIT DI RUOTE PIROETTANTI PER TAVOLI	15X10X15			

# PREPARAZIONE ECOLINE 700

## ARMADI CON PORTE A BATTENTE

Struttura portante chiusa con pannelli inox. Ripiano interno in acciaio inox spessore 0,8 mm regolabile su 3 altezze. Porte tamburate e insonorizzate battenti, in inox AISI 304. ...B: piano di lavoro bifronte. ...A: piano di lavoro con alzatina.

MOD. DESCRIZIONE



**EAB06B1**

TAVOLO ARMADIO CON PORTA BATTENTE, PIANO BIFRONTE

60X70X90



**EAB08B1**

TAVOLO ARMADIO CON PORTE BATTENTI, PIANO BIFRONTE

80X70X90

**EAB10B1**

TAVOLO ARMADIO CON PORTE BATTENTI, PIANO BIFRONTE

100X70X90



**EAB14BC3**

TAVOLO ARMADIO CON PORTE BATTENTI E CASSETTI, PIANO BIFRONTE

140X70X90



**EAB06A1**

TAVOLO ARMADIO CON PORTA BATTENTE, CON ALZATINA

60X70X90

**EAB08A1**

TAVOLO ARMADIO CON PORTA BATTENTE, CON ALZATINA

80X70X90

**EAB10A1**

TAVOLO ARMADIO CON PORTA BATTENTE, CON ALZATINA

100X70X90



**EAB14AC3**

TAVOLO ARMADIO CON PORTE BATTENTI E CASSETTI, CON ALZATINA

140X70X90

# PREPARAZIONE ECOLINE 700

## ARMADI CON PORTE A COULISSE

Struttura portante chiusa con pannelli inox. Ripiano interno in acciaio inox spessore 0,8 mm regolabile su 3 altezze. Porte tamburate e insonorizzate scorrevoli, in inox AISI 304. ...B: piano di lavoro bifronte. ...A: piano di lavoro con alzatina.

	MOD.	DESCRIZIONE				
	EA10B1	TAVOLO ARMADIO CON PORTE SCORREVOLI, PIANO BIFRONTE	100X70X90			
	EA12B1	TAVOLO ARMADIO CON PORTE SCORREVOLI, PIANO BIFRONTE	120X70X90			
	EA14B1	TAVOLO ARMADIO CON PORTE SCORREVOLI, PIANO BIFRONTE	140X70X90			
	EA16B1	TAVOLO ARMADIO CON PORTE SCORREVOLI, PIANO BIFRONTE	160X70X90			
	EA16BC3D	TAVOLO ARMADIO CON PORTE SCORREVOLI E CASSETTI, PIANO BIFRONTE	160X70X90			
	EA16BC3S	TAVOLO ARMADIO CON PORTE SCORREVOLI E CASSETTI, PIANO BIFRONTE	160X70X90			
	EA18B1	TAVOLO ARMADIO CON PORTE SCORREVOLI, PIANO BIFRONTE	180X70X90			
	EA18BC3D	TAVOLO ARMADIO CON PORTE SCORREVOLI E CASSETTI, PIANO BIFRONTE	180X70X90			
	EA18BC3S	TAVOLO ARMADIO CON PORTE SCORREVOLI E CASSETTI, PIANO BIFRONTE	180X70X90			
	EA20B1	TAVOLO ARMADIO CON PORTE SCORREVOLI, PIANO BIFRONTE	200X70X90			



MOD. DESCRIZIONE



**EA20BC3D**

TAVOLO ARMADIO CON PORTE SCORREVOLI E CASSETTI, PIANO BIFRONTE

200X70X90



**EA20BC3S**

TAVOLO ARMADIO CON PORTE SCORREVOLI E CASSETTI, PIANO BIFRONTE

200X70X90



**EA10A1**

TAVOLO ARMADIO CON PORTE SCORREVOLI, CON ALZATINA

100X70X90

**EA12A1**

TAVOLO ARMADIO CON PORTE SCORREVOLI, CON ALZATINA

120X70X90

**EA14A1**

TAVOLO ARMADIO CON PORTE SCORREVOLI, CON ALZATINA

140X70X90

**EA16A1**

TAVOLO ARMADIO CON PORTE SCORREVOLI, CON ALZATINA

160X70X90



**EA16AC3D**

TAVOLO ARMADIO CON PORTE SCORREVOLI E CASSETTI, CON ALZATINA

160X70X90



**EA16AC3S**

TAVOLO ARMADIO CON PORTE SCORREVOLI E CASSETTI, CON ALZATINA

160X70X90



**EA18A1**

TAVOLO ARMADIO CON PORTE SCORREVOLI, CON ALZATINA

180X70X90



**EA18AC3D**

TAVOLO ARMADIO CON PORTE SCORREVOLI E CASSETTI, CON ALZATINA

180X70X90



**EA18AC3S**

TAVOLO ARMADIO CON PORTE SCORREVOLI E CASSETTI, CON ALZATINA

180X70X90



**EA20A1**

TAVOLO ARMADIO CON PORTE SCORREVOLI, CON ALZATINA

200X70X90



MOD.	DESCRIZIONE				
	<b>EA20AC3D</b> TAVOLO ARMADIO CON PORTE SCORREVOLI E CASSETTI, CON ALZATINA	200X70X90			
	<b>EA20AC3S</b> TAVOLO ARMADIO CON PORTE SCORREVOLI E CASSETTI, CON ALZATINA	200X70X90			



# PREPARAZIONE ECOLINE 700

## ARMADI CASSETTIERA

Cassetti 1/1 GN ...B: piano di lavoro  
bifronte. ...A: piano di lavoro con  
alzatina.

MOD.

DESCRIZIONE



**EAC04BC3**

ARMADIO CASSETTIERA, 3  
CASSETTI 1/1 GN

40X70X90



**EAC04AC3**







ARMADIO CASSETTIERA CON  
ALZATINA, 3 CASSETTI 1/1 GN

40X70X90

# PREPARAZIONE ECOLINE 700

## TAVOLI ARMADI CALDI CON PORTE SCORREVOLI

Ripiano interno in acciaio inox spessore 0,8 mm regolabile su 3 altezze. Porte tamburate e insonorizzate scorrevoli, in inox AISI 304. Riscaldamento ventilato.  
...B: piano di lavoro bifronte. ...A: piano di lavoro con alzatina.

	MOD.	DESCRIZIONE	 cm	 kW	 kW	
	EA12B1E	TAVOLO ARMADIO CALDO 120X70 CM	120X70X90	1,25	230V 1N~ / 50 ÷ 60HZ	
	EA14B1E	TAVOLO ARMADIO CALDO 140X70 CM	140X70X90	1,25	230V 1N~ / 50 ÷ 60HZ	
	EA16B1E	TAVOLO ARMADIO CALDO 160X70 CM	160X70X90	1,25	230V 1N~ / 50 ÷ 60HZ	
	EA18B1E	TAVOLO ARMADIO CALDO 180X70 CM	180X70X90	1,25	230V 1N~ / 50 ÷ 60HZ	
	EA20B1E	TAVOLO ARMADIO CALDO 200X70 CM	200X70X90	1,25	230V 1N~ / 50 ÷ 60HZ	
	EA12A1E	TAVOLO ARMADIO CALDO CON ALZATINA 120X70 CM	120X70X90	1,25	230V 1N~ / 50 ÷ 60HZ	
	EA14A1E	TAVOLO ARMADIO CALDO CON ALZATINA 140X70 CM	140X70X90	1,25	230V 1N~ / 50 ÷ 60HZ	
	EA16A1E	TAVOLO ARMADIO CALDO CON ALZATINA 160X70 CM	160X70X90	1,25	230V 1N~ / 50 ÷ 60HZ	
	EA18A1E	TAVOLO ARMADIO CALDO CON ALZATINA 180X70 CM	180X70X90	1,25	230V 1N~ / 50 ÷ 60HZ	
	EA20A1E	TAVOLO ARMADIO CALDO CON ALZATINA 200X70 CM	200X70X90	1,25	230V 1N~ / 50 ÷ 60HZ	

# PREPARAZIONE ECOLINE 700

## TAVOLI ARMADIO PASSANTI CON PORTE SCORREVOLI

Ripiano interno in acciaio inox spessore 0,8 mm regolabile su 3 altezze. Porte tamburate e insonorizzate scorrevoli, in inox AISI 304. Apertura su due fronti.

MOD.	DESCRIZIONE	 cm	 kW	 kW	
 <b>EA10B2</b>	TAVOLO ARMADIO PASSANTE 100X70 CM	100X70X90			
<b>EA12B2</b>	TAVOLO ARMADIO PASSANTE 120X70 CM	120X70X90			
<b>EA14B2</b>	TAVOLO ARMADIO PASSANTE 140X70 CM	140X70X90			
<b>EA16B2</b>	TAVOLO ARMADIO PASSANTE 160X70 CM	160X70X90			
<b>EA18B2</b>	TAVOLO ARMADIO PASSANTE 180X70 CM	180X70X90			
<b>EA20B2</b>	TAVOLO ARMADIO PASSANTE 200X70 CM	200X70X90			

# PREPARAZIONE ECOLINE 700





## TAVOLI ARMADI CALDI PASSANTI CON PORTE SCORREVOLI

Ripiano interno in acciaio inox spessore 0,8 mm regolabile su 3 altezze. Porte tamburate e insonorizzate scorrevoli, in inox AISI 304. Riscaldamento ventilato. Apertura su due fronti.



MOD.	DESCRIZIONE				
<b>EA12B2E</b>	TAVOLO ARMADIO CALDO PASSANTE 120X70 CM	120X70X90	1,25	230V 1N~ / 50 ÷ 60HZ	
<b>EA14B2E</b>	TAVOLO ARMADIO CALDO PASSANTE 140X70 CM	140X70X90	1,25	230V 1N~ / 50 ÷ 60HZ	
<b>EA16B2E</b>	TAVOLO ARMADIO CALDO PASSANTE 160X70 CM	160X70X90	1,25	230V 1N~ / 50 ÷ 60HZ	
<b>EA18B2E</b>	TAVOLO ARMADIO CALDO PASSANTE 180X70 CM	180X70X90	1,25	230V 1N~ / 50 ÷ 60HZ	
<b>EA20B2E</b>	TAVOLO ARMADIO CALDO PASSANTE 200X70 CM	200X70X90	1,25	230V 1N~ / 50 ÷ 60HZ	

### ACCESSORI

MOD.	DESCRIZIONE				
<b>KRPECOAC</b>	KIT DI RUOTE PIROETTANTI PER ARMADI E CASSETTIERE				

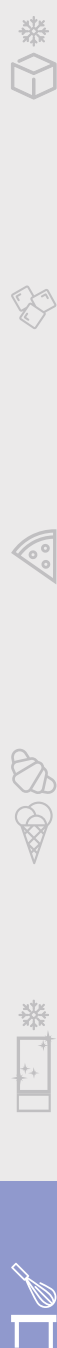

# PREPARAZIONE ECOLINE 700

## ARMADI PORTASTOVIGLIE CON PORTE SCORREVOLI

3 ripiani interni in acciaio inox spessore 0,8 mm, regolabili su 3 altezze. Porte tamburate e insonorizzate scorrevoli, in acciaio inox AISI 304.



MOD.	DESCRIZIONE	 cm	 kW	 kW	
<b>E12AP</b>	ARMADIO PORTASTOVIGLIE PORTE SCORREVOLI	120X70X200			
<b>E14AP</b>	ARMADIO PORTASTOVIGLIE PORTE SCORREVOLI	140X70X200			
<b>E16AP</b>	ARMADIO PORTASTOVIGLIE PORTE SCORREVOLI	160X70X200			
<b>E18AP</b>	ARMADIO PORTASTOVIGLIE PORTE SCORREVOLI	180X70X200			
<b>E20AP</b>	ARMADIO PORTASTOVIGLIE PORTE SCORREVOLI	200X70X200			

# PREPARAZIONE ECOLINE 700

## TAVOLI CON VASCA

Alzatina h 100 mm, raggiata alla base.  
 Vasca in inox AISI 304 spessore 1 mm  
 50x40x25 h cm. In dotazione: piletta  
 di scarico da 1,5", tubo troppopieno e  
 sifone.

	MOD.	DESCRIZIONE				
	<b>E12TAVD</b>	TAVOLO CON PIANO E ALZATINA VASCA DESTRA 120 CM	120X70X90			
	<b>E16TAVD</b>	TAVOLO CON PIANO E ALZATINA VASCA DESTRA 160 CM	160X70X90			
	<b>E18TAVD</b>	TAVOLO CON PIANO E ALZATINA VASCA DESTRA 180 CM	180X70X90			
	<b>E12TAVS</b>	TAVOLO CON PIANO E ALZATINA VASCA SINISTRA 120 CM	120X70X90			
	<b>E16TAVS</b>	TAVOLO CON PIANO E ALZATINA VASCA SINISTRA 160 CM	160X70X90			
	<b>E18TAVS</b>	TAVOLO CON PIANO E ALZATINA VASCA SINISTRA 180 CM	180X70X90			



# PREPARAZIONE ECOLINE 700

## LAVELLI SU GAMBE

Alzatina h 100mm, raggiata alla base.  
 Vasca stampata in inox AISI 304  
 spessore 1 mm. In dotazione: piletta  
 di scarico da 1,5", tubo troppopieno e  
 sifone. Pannello copri vasca in inox AISI  
 304 spessore 0,8 mm. Ripiano di fondo.

	MOD.	DESCRIZIONE	 cm	 kW	 kW	
	<b>E07L15</b>	LAVELLO SU GAMBE 1 VASCA CM 50X50X30H	70X70X90			
	<b>E08L165</b>	LAVELLO SU GAMBE 1 VASCA CM 60X50X30H	80X70X90			
	<b>E10L15D</b>	LAVELLO SU GAMBE 1 VASCA CM 50X50X30H SGOCCIOLATOIO A DESTRA	100X70X90			
	<b>E10L15S</b>	LAVELLO SU GAMBE 1 VASCA CM 50X50X30H SGOCCIOLATOIO A SINISTRA	100X70X90			
	<b>E10L245</b>	LAVELLO SU GAMBE 2 VASCHE CM 40X50X30H	100X70X90			
	<b>E10L18</b>	LAVELLO PER PENTOLE 1 VASCA CON RIPIANO 100 CM	100X70X90			
	<b>E12L15D</b>	LAVELLO SU GAMBE 1 VASCA CM 50X50X30H SGOCCIOLATOIO A DESTRA	120X70X90			
	<b>E12L15S</b>	LAVELLO SU GAMBE 1 VASCA CM 50X50X30H SGOCCIOLATOIO A SINISTRA	120X70X90			



MOD.	DESCRIZIONE	 cm	 kW	 kW	
	<b>E12L25</b> LAVELLO SU GAMBE 2 VASCHE CM 50X50X30H	120X70X90			
	<b>E12L111</b> LAVELLO PER PENTOLE 1 VASCA CON RIPIANO 120 CM	120X70X90			
	<b>E14L15D</b> LAVELLO SU GAMBE 1 VASCA CM 50X50X30H SGOCCIOLATOIO A DESTRA	140X70X90			
	<b>E14L15S</b> LAVELLO SU GAMBE 1 VASCA CM 50X50X30H SGOCCIOLATOIO A SINISTRA	140X70X90			
	<b>E14L112</b> LAVELLO PER PENTOLE 1 VASCA CON RIPIANO 140 CM	140X70X90			
	<b>E14L265</b> LAVELLO SU GAMBE 2 VASCHE CM 60X50X30H	140X70X90			
	<b>E16L25D</b> LAVELLO SU GAMBE 2 VASCHE CM 50X50X30H SGOCCIOLATOIO A DESTRA	160X70X90			
	<b>E16L25S</b> LAVELLO SU GAMBE 2 VASCHE CM 50X50X30H SGOCCIOLATOIO A SINISTRA	160X70X90			
	<b>E16L114</b> LAVELLO PER PENTOLE 1 VASCA CON RIPIANO 160 CM	160X70X90			





MOD. DESCRIZIONE



**E16L27**

LAVELLO PER PENTOLE 2 VASCHE  
CON RIPIANO 160 CM

160X70X90



**E18L265D**

LAVELLO SU GAMBE 2 VASCHE CM  
60X50X30H SGOCCIOLATOIO A  
DESTRA

180X70X90



**E18L265S**

LAVELLO SU GAMBE 2 VASCHE CM  
60X50X30H SGOCCIOLATOIO A  
SINISTRA

180X70X90



**E18L28**

LAVELLO PER PENTOLE 2 VASCHE  
CON RIPIANO 180 CM

180X70X90



**E20L265D**

LAVELLO SU GAMBE 2 VASCHE CM  
60X50X30H SGOCCIOLATOIO A  
DESTRA

200X70X90



**E20L265S**

LAVELLO SU GAMBE 2 VASCHE CM  
60X50X30H SGOCCIOLATOIO A  
SINISTRA

200X70X90



**E20L28**













LAVELLO PER PENTOLE 2 VASCHE  
CON RIPIANO 200 CM

200X70X90

# PREPARAZIONE ECOLINE 700

## LAVELLI SU ARMADIO

Alzatina h 100mm, raggiata alla base.  
Vasca stampata in inox AISI 304  
spessore 1 mm. In dotazione: piletta  
di scarico da 1,5", tubo troppopieno e  
sifone. Porte tamburate e insonorizzate  
scorrevoli in acciaio inox AISI 304  
(portine battenti per modelli ...07... e  
...08...).

	MOD.	DESCRIZIONE				
	ELA0715	LAVELLO SU ARMADIO 1 VASCA CM 50X50X30H	70X70X90			
	ELA08165	LAVELLO SU ARMADIO 1 VASCA CM 60X50X30H	80X70X90			
	ELA1015D	LAVELLO SU ARMADIO 1 VASCA CM 50X50X30H SGOCCIOLATOIO A DESTRA	100X70X90			
	ELA1015S	LAVELLO SU ARMADIO 1 VASCA CM 50X50X30H SGOCCIOLATOIO A SINISTRA	100X70X90			
	ELA1215D	LAVELLO SU ARMADIO 1 VASCA CM 50X50X30H SGOCCIOLATOIO A DESTRA	120X70X90			
	ELA1215S	LAVELLO SU ARMADIO 1 VASCA CM 50X50X30H SGOCCIOLATOIO A SINISTRA	120X70X90			
	ELA1225	LAVELLO SU ARMADIO 2 VASCHE CM 50X50X30H	120X70X90			
	ELA1415D	LAVELLO SU ARMADIO 1 VASCA CM 50X50X30H SGOCCIOLATOIO A DESTRA	140X70X90			



MOD. DESCRIZIONE



**ELA1415S** LAVELLO SU ARMADIO 1 VASCA  
CM 50X50X30H SGOCCIOLATOIO A  
SINISTRA 140X70X90



**ELA1625D** LAVELLO SU ARMADIO 2 VASCHE  
CM 50X50X30H SGOCCIOLATOIO  
A DESTRA 160X70X90



**ELA1625S** LAVELLO SU ARMADIO 2 VASCHE  
CM 50X50X30H SGOCCIOLATOIO A  
SINISTRA 160X70X90



**ELA1826D** LAVELLO SU ARMADIO 2 VASCHE  
CM 60X50X30H SGOCCIOLATOIO  
A DESTRA 180X70X90





**ELA1826S** LAVELLO SU ARMADIO 2 VASCHE  
CM 60X50X30H SGOCCIOLATOIO A  
SINISTRA 180X70X90

# PREPARAZIONE ECOLINE 700

## LAVELLI PREDISPOSTI PER LAVASTOVIGLIE

Alzatina h 100mm, raggiata alla base.  
 Vasca stampata in inox AISI 304  
 spessore 1 mm. In dotazione: piletta  
 di scarico da 1,5", tubo troppopieno e  
 sifone. Pannello copri vasca in inox AISI  
 304 spessore 0,8 mm. Ripiano di fondo.

	MOD.	DESCRIZIONE				
	E12L15DL	LAVELLO SU GAMBE 1 VASCA CM 50X50X30H SGOCCIOLATOIO A DESTRA	120X70X90			
	E12L15SL	LAVELLO SU GAMBE 1 VASCA CM 50X50X30H SGOCCIOLATOIO A SINISTRA	120X70X90			
	E14L15DL	LAVELLO SU GAMBE 1 VASCA CM 50X50X30H SGOCCIOLATOIO A DESTRA	140X70X90			
	E14L15SL	LAVELLO SU GAMBE 1 VASCA CM 50X50X30H SGOCCIOLATOIO A SINISTRA	140X70X90			
	E16L24DL	LAVELLO SU GAMBE 2 VASCHE CM 40X50X30H SGOCCIOLATOIO A DESTRA	160X70X90			
	E16L24SL	LAVELLO SU GAMBE 2 VASCHE CM 40X50X30H SGOCCIOLATOIO A SINISTRA	160X70X90			
	E18L25DL	LAVELLO SU GAMBE 2 VASCHE CM 50X50X30H SGOCCIOLATOIO A DESTRA	180X70X90			
	E18L25SL	LAVELLO SU GAMBE 2 VASCHE CM 50X50X30H SGOCCIOLATOIO A SINISTRA	180X70X90			





MOD. DESCRIZIONE



**E20L26DL** LAVELLO SU GAMBE 2 VASCHE CM 60X50X30H SGOCCIOLATOIO A DESTRA 200X70X90



**E20L26SL** LAVELLO SU GAMBE 2 VASCHE CM 60X50X30H SGOCCIOLATOIO A SINISTRA 200X70X90



**ELA121DL** LAVELLO ARMADIATO PREDISPOSTO PER LAVASTOVIGLIE 120X70X90



**ELA121SL** LAVELLO ARMADIATO PREDISPOSTO PER LAVASTOVIGLIE 120X70X90



**ELA141DL** LAVELLO ARMADIATO PREDISPOSTO PER LAVASTOVIGLIE 140X70X90



**ELA141SL** LAVELLO ARMADIATO PREDISPOSTO PER LAVASTOVIGLIE 140X70X90



**ELA162DL** LAVELLO ARMADIATO PREDISPOSTO PER LAVASTOVIGLIE 160X70X90



**ELA162SL** LAVELLO ARMADIATO PREDISPOSTO PER LAVASTOVIGLIE 160X70X90



**ELA182DL** LAVELLO ARMADIATO PREDISPOSTO PER LAVASTOVIGLIE 180X70X90

MOD.

DESCRIZIONE



**ELA182SL**

LAVELLO ARMADIATO  
PREDISPOSTO PER LAVASTOVIGLIE









180X70X90



# PREPARAZIONE ECOLINE 700

## ACCESSORI PER LAVELLI

### ACCESSORI



	MOD.	DESCRIZIONE	 cm	 kW	 kW	
	CEM	GRUPPO MISCELATORE ACQUA CALDA/FREDDA				
	CEG	GRUPPO MISCELATORE ACQUA CALDA/FREDDA A GOMITO				
	DF	DOCCIA FISSA	12X40X105			
	EEAP	GRUPPO EROGATORE A PEDALE LAVELLI CON RIPIANO DI FONDO				
	EEAPARM	GRUPPO EROGATORE A PEDALE PER LAVELLI ARMADIATI				
	PULIPE	PULISCIPENTOLE ELETTRICO DA BANCO	18X29X24	0,18	230V 1N~ / 50HZ	



# PREPARAZIONE ECOLINE 700

## PENSILI

...G: versione a giorno. ...C: con portine a coulisse. ...B: con portine battente.  
 ...SC: con portine a coulisse e ripiano scolapiatti.

	MOD.	DESCRIZIONE				
	E06PG	PENSILE A GIORNO 60 CM	60X40X66			
	E08PG	PENSILE A GIORNO 80 CM	80X40X66			
	E10PG	PENSILE A GIORNO 100 CM	100X40X66			
	E12PG	PENSILE A GIORNO 120 CM	120X40X66			
	E14PG	PENSILE A GIORNO 140 CM	140X40X66			
	E16PG	PENSILE A GIORNO 160 CM	160X40X66			
	E18PG	PENSILE A GIORNO 180 CM	180X40X66			
	E10PC	PENSILE CON 2 PORTE SCORREVOLI 100 CM	100X40X66			
	E12PC	PENSILE CON 2 PORTE SCORREVOLI 120 CM	120X40X66			
	E14PC	PENSILE CON 2 PORTE SCORREVOLI 140 CM	140X40X66			
	E16PC	PENSILE CON 2 PORTE SCORREVOLI 160 CM	160X40X66			
	E18PC	PENSILE CON 2 PORTE SCORREVOLI 180 CM	180X40X66			
	E10PSC	PENSILE SCOLAPIATTI CON 2 PORTE SCORREVOLI 100 CM	100X40X66			
	E12PSC	PENSILE SCOLAPIATTI CON 2 PORTE SCORREVOLI 120 CM	120X40X66			
	E14PSC	PENSILE SCOLAPIATTI CON 2 PORTE SCORREVOLI 140 CM	140X40X66			
	E16PSC	PENSILE SCOLAPIATTI CON 2 PORTE SCORREVOLI 160 CM	160X40X66			
	E18PSC	PENSILE SCOLAPIATTI CON 2 PORTE SCORREVOLI 180 CM	180X40X66			
E06PB	PENSILE CON PORTA BATTENTE 60 CM	60X40X66				





MOD. DESCRIZIONE



**E08PB**

PENSILE CON 2 PORTA BATTENTE  
80 CM

80X40X66

**E10PB**

PENSILE CON 2 PORTE BATTENTE  
100 CM

100X40X66

**E12PB**



PENSILE CON 2 PORTA BATTENTE  
120 CM

120X40X66

# PREPARAZIONE ECOLINE 700

## SCAFFALI







4 ripiani in acciaio inox, spessore 0,8 mm. Gambe in acciaio inox spessore 1,2 mm con fori per fissaggio ripiani passo 200 mm. In dotazione: accessori per il fissaggio ripiani e piedi. Portata 150 kg uniformemente distribuiti sul ripiano. Consegnati smontati.

	MOD.	DESCRIZIONE	 cm	 kW	 kW	
	<b>E10SR</b>	SCAFFALE 4 RIPIANI	100X50X180			
	<b>E12SR</b>	SCAFFALE 4 RIPIANI	120X50X180			
	<b>E14SR</b>	SCAFFALE 4 RIPIANI	140X50X180			
	<b>E16SR</b>	SCAFFALE 4 RIPIANI	160X50X180			
	<b>E18SR</b>	SCAFFALE 4 RIPIANI	180X50X180			
	<b>E20SR</b>	SCAFFALE 4 RIPIANI	200X50X180			

# PREPARAZIONE ECOLINE 700

## LAVAMANI







In dotazione pulsante e rubinetto di erogazione acqua e piletta di scarico da 1,5". ...G: a ginocchio.

	MOD.	DESCRIZIONE	 cm	 kW	 kW	
	ELMG	LAVAMANI A PARETE CON COMANDO A GINOCCHIO	40X40X25			
	ELMP	LAVAMANI SU ARMADIO CON COMANDO A GINOCCHIO	50X50X85			

# PREPARAZIONE ECOLINE 700

## PIANI SINGOLI PER BASI REFRIGERATE

Installabile esclusivamente sulle basi refrigerate Angelo Po. Predisposto per il fissaggio sottopiano di base refrigerata.

MOD.	DESCRIZIONE				
	<b>E115SB</b>	PIANO BIFRONTE H 4 CM PER BASE REFRIGERATA 115 CM	115X70X4		
	<b>E140SB</b>	PIANO BIFRONTE H 4 CM PER BASE REFRIGERATA 140 CM	140X70X4		
	<b>E160SB</b>	PIANO BIFRONTE H 4 CM PER BASE REFRIGERATA 160 CM	160X70X4		
	<b>E190SB</b>	PIANO BIFRONTE H 4 CM PER BASE REFRIGERATA 190 CM	190X70X4		
	<b>E205SB</b>	PIANO BIFRONTE H 4 CM PER BASE REFRIGERATA 205 CM	205X70X4		
	<b>E230SB</b>	PIANO BIFRONTE H 4 CM PER BASE REFRIGERATA 230 CM	230X70X4		
	<b>E115SA</b>	PIANO CON ALZATINA H 4 CM PER BASE REFRIGERATA 115 CM	115X70X10		
	<b>E140SA</b>	PIANO CON ALZATINA H 4 CM PER BASE REFRIGERATA 140 CM	140X70X10		
	<b>E160SA</b>	PIANO CON ALZATINA H 4 CM PER BASE REFRIGERATA 160 CM	160X70X10		
	<b>E190SA</b>	PIANO CON ALZATINA H 4 CM PER BASE REFRIGERATA 190 CM	190X70X10		
	<b>E205SA</b>	PIANO CON ALZATINA H 4 CM PER BASE REFRIGERATA 205 CM	205X70X10		
	<b>E230SA</b>	PIANO CON ALZATINA H 4 CM PER BASE REFRIGERATA 230 CM	230X70X10		



Vaillant - Italy